

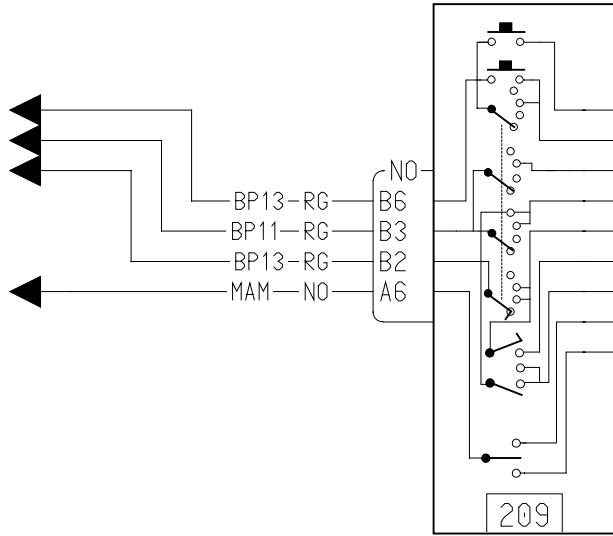

H79

11

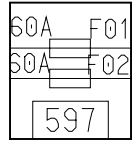

BP13-RG B6
BP11-RG B3
BP13-RG B2
MAM-NO A6

NO
A4
B7
B4
B1
A3
A1
A7
A5

67C-GR
R-GR
CDO-SA
L-VE
9J-SA
8A-BA
64T-MA
64S-BA

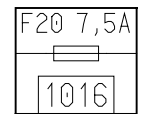
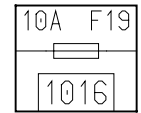
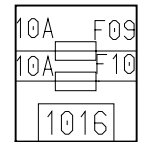
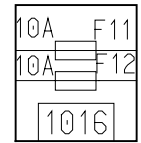
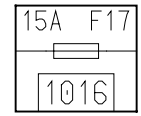

231

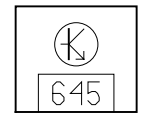

3-38